

# **StarBoard FX-TRIO-63E**

# **StarBoard FX-TRIO-77E**

---

## **User's Guide**

Read this User's Guide and carefully retain it for future reference.

Before using this product, carefully read and fully understand the safety instructions. Store this User's Guide nearby for ease of reference.

## **Notices**

Reproduction or reprinting, without permission, of this User's Guide or any part thereof is prohibited.

The contents of this User's Guide are subject to change without prior notice.

Every effort has been made to ensure that this User's Guide is complete and correct. However, should any questionable points, mistakes, etc., come to your attention, please inform the vendor.

Hitachi Solutions, Ltd. assumes no responsibility for losses resulting from or related to the use of this product. Refer to "3. Appendix 3.7 Product Warranty Policy" at the end of this User's Guide for details on the warranty and liabilities.

## **Precautions Regarding Disposal**

At time of disposal, handle this product as industrial waste according to all applicable laws and regulations.

## **Disclaimers**

Hitachi Solutions, Ltd. assumes no liability and makes no warranty, either express or implicit, regarding the contents of this User's Guide.

Also, the company makes no warranty as to the product's suitability, merchantability or fitness for a particular intended use.

All products of Hitachi Solutions, Ltd. described in this User's Guide are presently for sale or are site-licensed.

Users who purchased the aforesaid product(s) will bear the costs of all required services, repairs, and damages resulting from defects in this product, and will bear the costs of direct or indirect damages (including the loss of profits or required information) that resulted from the product defects.

Moreover, Hitachi Solutions, Ltd. retains the right to revise this User's Guide and to modify the contents thereof, without any obligation to notify anyone.

## **Product Assurance Provisions**

This product is limited to use in the country where the user bought this product.

For warranty details, refer to "3. Appendix 3.7 Product Warranty Policy" at the end of this User's Guide.

This second edition of the User's Guide (FXTE-ML110801) is for the following products:

AH00300:	StarBoard FX-TRIO-63E
AH00271:	StarBoard FX-TRIO-77E
AH00180:	Electronic Pen

Windows is a trademark of Microsoft Corporation (U.S.) and in other countries.

Mac and Mac OS are trademarks of Apple Inc., registered in the U.S. and other countries.

Other trademarks and product names are trademarks and/or registered trademarks of their respective holders

### **Manual Creation Dates**

August 2011, Second edition      FXTE-ML110801

All Right Reserved, Copyright(c) 2011, Hitachi Solutions, Ltd.

## **Introduction**

Thank you very much for purchasing Hitachi solutions' StarBoard FX-TRIO-63E/77E (henceforth referred to as "StarBoard").

This User's Guide has been created for people who already have a working knowledge of personal computers (henceforth referred to as "PC").



Please make sure that you understand the contents of this User's Guide and use the software correctly.



We hope that you make the most of this product.

## Safe Handling

### Markings and Symbols

Various markings and symbols are used in this User's Guide and on this product, to ensure the safe and correct use of this product and to prevent personal injury and property damage. These symbols and their meanings are as explained below. Understand the information well before reading the body of the User's Guide.





	This is a Safety Warning symbol. This symbol will appear to raise the attention of the user to existing risks that may cause harm to people. To avoid any chances of injuries or possibly death, <b>DO NOT IGNORE</b> the safety instructions that follow this symbol.
 <b>WARNINGS</b>	This warning will appear where there exists a risk of death or fatal injuries.
 <b>CAUTIONS</b>	This warning will appear where there exists a risk of moderate or light injuries.
<b>NOTICE</b>	This warning will appear where there exists a risk of damage to property.



	This symbol draws attention to cautions (including warnings).
	This symbol indicates something prohibited.
	This symbol indicates something that must be done.





# Safe Precautions

## Required Precautions



### (1) Precautions Regarding Operation

 <b>WARNINGS</b>	
	<p><b>Do not make modifications.</b></p> <p>Do not make any adjustments, repairs, or modifications not given in this User's Guide as doing so may lead to personal injury or damage to the product.</p>
	<p><b>Do not open or remove cover of this product.</b></p> <p>Failure to comply may lead to personal injury or damage to the product. Refer internal inspections, adjustments, and repairs to your dealer or support center.</p>
	<p><b>Do not place objects on top of this product.</b></p> <p>If a foreign object falls on top of or inside this product, it may lead to personal injury or damage to the product.</p>







 <b>CAUTIONS</b>	
	<p><b>In order to prevent damage by static electricity, touch a nearby metal object with your hand to discharge any static electricity before touching this product.</b></p> <p>Static electricity from your body may cause damage to this product.</p>



<b>NOTICE</b>	
	<p><b>Make sure that the silver surfaces of the reflective bars do not become dirty or scratched.</b></p> <p>Scratches or dirt on the silver surfaces of the reflective bars may prevent them from detecting coordinates correctly.</p>
	<p><b>Do not use a USB cable extended.</b></p> <p>Use of a USB cable extended may result in malfunction.</p>
	<p><b>Do not place heavy objects on, pull on, or subject the USB cable to excess heat.</b></p> <p>Failure to comply may result damage to the USB cable.</p>
	<p><b>Always grasp the plug of the USB cable when connecting or disconnecting.</b></p> <p>Pulling on the USB cable may result in scratching or damage to the cable.</p>

**(2) Dealing with Trouble**



 <b>CAUTIONS</b>	
	<p><b>What to do in case of emission of smoke, strange odor, or strange noise</b></p> <p>If an abnormal condition such as emission of smoke, strange odor, or strange noise happens to occur for some reason, immediately disconnect the product's USB cable from the PC.</p> <p>Confirm that the smoke or strange odor is no longer being emitted and contact a support center to request repairs.</p> <p>Continued operation without repair may result in fire.</p>
	<p><b>What to do if the product breaks or the USB cable is damaged</b></p> <p>If this product breaks or the USB cable becomes damaged for some reason, immediately disconnect the USB cable from the PC and contact a support center.</p> <p>Continued operation without repair may result in emission of a strange odor or smoke.</p>



**(3) Precautions Regarding Handling**

 <b>WARNINGS</b>	
	<p><b>Do not hang from or climb on this product.</b></p> <p>Failure to comply may result in personal injury if the product falls, collapses, or breaks into pieces. Be particularly careful in the case of small children.</p>
	<p><b>Do not touch this product if you hear thunder.</b></p> <p>Failure to comply may result in electric shock.</p>
 <b>CAUTIONS</b>	
	<p><b>Do not use batteries other than those specified.</b></p> <p>Failure to comply may result in fire, personal injury, and/or soiling of the surrounding area due to batteries bursting or leaking fluid.</p>
	<p><b>Do not splash with water or chemical compounds.</b></p> <p>Do not place this product in a location subject to contact with water droplets or place any containers containing water or other chemical compounds on top of or nearby this product.</p> <p>Failure to comply may result in damage or fire if water or chemical compounds get inside this product.</p>

<b>NOTICE</b>	
	<p><b>Disconnect the USB cable during extended periods of non-use.</b></p> <p>For safety reasons, disconnect the USB cable if the product is not going to be used for an extended period of time. Failure to comply may result in malfunction.</p>
	<p><b>Handle the connection cable properly.</b></p> <p>Improper handling of the connection cable such as jamming it against a wall, undue bending, pulling, or twisting may result in overheating or damage due to exposure of the conductive core, electrical short, or severing of the cable.</p>





**(4) Precautions Regarding Moving the Product**





 <b>CAUTIONS</b>	
	<p><b>Always use two or more people to move this product.</b></p> <p>This product is a very large and heavy precision instrument. Always use two or more people and take great care when moving this product. Result in the personal injury or breakdown if the product falls over.</p>





<b>NOTICE</b>	
	<p><b>Always disconnect the USB cable from the PC when moving this product.</b></p> <p>Failure to comply may result in damage to the USB cable and/or the product itself.</p>
	<p><b>Do not subject to shock of impact.</b></p> <p>This product is a precision instrument. Excessive shock of impact may hinder further operation.</p> <p>Take extreme care when moving this product.</p>



**(5) Precautions Regarding Setup Environment**

 <b>WARNINGS</b>	
	<p><b>Wall mounting work should be performed by a construction specialist.</b> Improper work may result in death or personal injury due to the product falling during operation. Always use the specified mounting unit.</p>
	<p><b>Improper assembly may cause the product to fall over.</b> There is risk of personal injury if the product falls over. Completely tighten the screws of all individual parts.</p>
	<p><b>Install this product on a flat wall.</b> Installing this product on an uneven wall such as bumpy or curved surfaces may cause the product to operate improperly or fall over, resulting in personal injury or product malfunction.</p>
	<p><b>Do not place in a location with flammable or corrosive gas.</b> Placing this product in a location where there is flammable or corrosive gas may result in fire or damage to this product. There is a particular danger of explosion in the case of flammable gas. Do not place in a location with flammable or corrosive gas.</p>

 <b>CAUTIONS</b>	
	<p><b>Do not touch internally mounted parts.</b> Directly touching internally mounted parts inside this product may result in personal injury or damage to this product.</p>
	<p><b>Do not place in locations subject to excess moisture, dust, smoke, or steam.</b> Placement in a location such as next to a kitchen or a humidifier may result in fire or damage to this product.</p>
	<p><b>Do not use this product near water.</b> If water somehow gets inside this product, immediately disconnect the USB cable and contact a support center. Continued use may result in fire or damage to this product.</p>

<b>NOTICE</b>	
	<p><b>Do not use this product in locations subject to high temperature or high humidity.</b>                      This product's usage environment conditions:                      Temperature: 5°C – 35°C                      Humidity: 20%RH – 80%RH (no condensation)</p>
	<p><b>Do not set up in locations subject to vibration and/or shock of impact.</b>                      Vibration and/or shock of impact may harm internal components of this product, resulting in damage to it. Do not set up this product in a location subject to vibration or shock of impact.</p>
	<p><b>Do not set up this product near a high-voltage line or power source.</b>                      If this product is set up near high-voltage lines or power sources, it might receive interference.</p>
	<p><b>Do not set up in a location subject to direct sunlight or near a heater.</b>                      Failure to comply may result in deformation of or damage to this product.</p>

**(6) Precautions Regarding Disposal**

<b>NOTICE</b>	
	<p><b>At time of disposal, handle this product as industrial waste according to all applicable laws and regulations.</b>                      When disposing of this product, the user should follow all laws and regulations of the locality in which it is being used.</p>

Careful thought was given to the cautions on this device and in this User's Guide. However, unanticipated circumstances might occur. When operating this product, users themselves must exercise caution as well as follow instructions.

 **WARNINGS**

Warnings Contents	Page(s)
<p><b>Install this product on a vertical and flat surface.</b> Do not install this product on a slanting surface, ceiling or uneven wall. Otherwise, the equipment might fall, possibly resulting in injury, or the impact might cause product failure.</p>	P.1-6
<p><b>Keep the wall material in mind when installing.</b> Installation by means not suited to the wall material in question may result in the board falling. Furthermore, wall installation may not be possible depending on the wall. For details, consult with your dealer.</p>	P.1-7
<p><b>Keep the wall strength in mind when installing.</b> Only use this product after confirming that it is securely attached and will not fall. Furthermore, be sure to install using a wall-mounting bracket capable of supporting a weight of at least 30 kg.</p>	P.1-7

 **CAUTIONS**

Cautions Contents	Page(s)
<p><b>Be sure to use two or more people for this work.</b> Failure to comply may cause the board to fall, resulting in personal injury, or may cause damage to this product due to shock of impact.</p>	P.1-8
<p><b>Do not strike the board forcefully with the stylus pen, bend it, or apply an excessive load to it.</b> Failure to comply may result in damage to the stylus pen or personal injury.</p>	P.2-3
<p><b>Be sure to install batteries correctly.</b> Do not install batteries with positive and negative terminals reversed, or use batteries other than the type specified. It will cause pen malfunctions and excess heat, or burns to the hand.</p>	P.2-4
<p><b>Be sure to provide insulation during disposal.</b> Be sure to insulate the positive and negative terminals of the battery using cellophane tape, or similar material when disposing of batteries. Disposing of batteries without insulating them may lead to overheating, bursting, or ignition due to shorting, resulting in personal injury or fire. Furthermore, be sure to follow all local rules and regulations regarding proper battery disposal.</p>	P.2-4

**NOTICE**

Notice Contents	Page(s)
<ul style="list-style-type: none"> <li>- Do not set it up near equipment that might generate electromagnetic waves or radio frequencies, such as radio transmitters, televisions, copying machines or air conditioners.</li> <li>- Avoid locations that are dusty, that are subject to extremely high or low temperatures or humidity, or that are exposed to direct sunlight.</li> </ul>	P.1-6
<p><b>Do not scrape or strike the board surface by stylus pen.</b> Failure to comply may result in damage on the board surface.</p>	P.2-1
<p><b>Use an input tool with a thickness of least 7 mm.</b> When inputting to this product, use a tool that is at least 7 mm. If a pen or similar tool with a thickness of less than 7 mm is used, the input will be unstable. Also, do not use tools with a sharp tip, such as a ballpoint pen. If such a tool is used incorrectly, it could damage the surface of the board.</p>	P.2-1
<p><b>Using infrared and compact cameras, this product captures the image (shadow) of a pen or finger and detects the corresponding coordinate position. Do not operate near lighting that will obstruct the capture of the image.</b></p> <ul style="list-style-type: none"> <li>- Locations where the surface or side of the projection area are exposed to direct sunlight.</li> <li>- Locations in which there are light fittings with many light bulbs or infrared rays directly above the projection area.</li> </ul>	P.3-5 P.3-9

## Contents

<b>1. INTRODUCTION .....</b>	<b>1-1</b>
1.1 PREPARATIONS.....	1-1
1.1.1 Product Outline .....	1-1
1.1.2 Features .....	1-1
1.2 PARTS CHECK .....	1-2
1.2.1 StarBoard.....	1-2
1.2.2 Electronic Pen (option) .....	1-3
1.3 ROLE OF EACH PART.....	1-4
1.3.1 StarBoard.....	1-4
1.3.2 Function Area .....	1-5
1.3.3 Electronic Pen (option) .....	1-6
1.4 ASSEMBLY AND SETUP .....	1-6
1.4.1 Setup Method.....	1-7
1.4.2 Equipment Connection Method .....	1-10
<b>2. HOW TO USE .....</b>	<b>2-1</b>
2.1 HOW TO USE TOUCH MODE.....	2-1
2.1.1 Character Input .....	2-1
2.1.2 PC Operations.....	2-2
2.2 HOW TO USER THE ELECTRONIC PEN .....	2-4
2.2.1 Inserting the Battery.....	2-4
2.2.2 Using the Electronic Pen .....	2-5
2.2.3 Basic Operations of the Electronic Pen .....	2-6
2.2.4 Customizing the Electronic Pen.....	2-6
2.3 START METHOD .....	2-7
2.3.1 Start Method (Windows version).....	2-7
2.3.2 Start Method (Mac version).....	2-8
<b>3. APPENDIX.....</b>	<b>3-1</b>
3.1 TROUBLESHOOTING.....	3-1
“Optical Touch Sensor” exists on USB controller of the Device Manager. ....	3-1
3.2 ADJUSTING THE SENSOR .....	3-5
3.2.1 Items to Check Before Making Sensor Adjustments .....	3-5
3.2.2 Sensor Adjustment Procedure (Windows version).....	3-5
3.2.3 Sensor Adjustment Procedure (Mac version).....	3-7
3.3 REGULARLY AUTO SENSOR ADJUSTMENT (FOR WINDOWS) .....	3-9
3.3.1 Sensor Auto Adjustment Procedure.....	3-9
3.4 SYSTEM SPECIFICATIONS .....	3-11
1511(W)×1,260(H)×65 (D).....	3-11
(not including fitting metal of lower board on a wall) .....	3-11
3.5 PROPER CARE AND CLEANING .....	3-12
3.6 REPLACEABLE PARTS.....	3-12
3.7 PRODUCT WARRANTY POLICY .....	3-13

## 1. Introduction

### 1.1 Preparations

This chapter describes the preparations to be made before using StarBoard.

First-time users of StarBoard should read through this chapter.

#### 1.1.1 Product Outline

The StarBoard FX-TRIO-63E/77E is an extremely convenient and easy-to-use electronic whiteboard. After setting up the provided software on a PC that is connected to a projector, you can use your finger or the stylus pen that is included with the product to operate the PC or import to the PC in real time characters or images that are drawn on the whiteboard.

#### 1.1.2 Features

- You can use your finger or the pen to operate the PC

You can use your finger or the pen to operate a PC screen that is projected onto the board with a projector. Two pen types are available: the stylus pen that is included with the product, and an electronic pen that is option. When the term “pen” is used in this User’s Guide, it means “electronic pen.”

- You can write three people at the same time

Three people can input simultaneously with dedicated purpose tools or contents. It is effective for class and presentation.

- You can write directly onto the PC screen

After installing the provided StarBoard Software onto a PC, you can use your finger or the pen to write characters or images directly onto the PC screen. The input characters or drawn images are imported as digital data in real time into the PC, where they can be saved or printed.

- Compatible with PowerPoint presentations

Characters or images can be written into presentations created with Microsoft PowerPoint, which significantly improves the expressive power of the presentations.

- You can also write on video images (For Windows)

Characters or images can be written onto captured video image displays.

This makes it easy to use video materials in lessons or presentations.

## 1.2 Parts Check

After unpacking, make sure that all the following parts are present.

### 1.2.1 StarBoard

[1] Parts

No.	Name	Qty
(1)	StarBoard	1
(2)	Wall-mounting bracket	1
(3)	Brush	1
(4)	Stylus pen	1
(5)	StarBoard Software DVD-ROM	1
(6)	StarBoard Software Startup Guide	1
(7)	StarBoard FX-TRIO-63E/77E Startup guide	1
(8)	Warranty Sheet	1

(1)

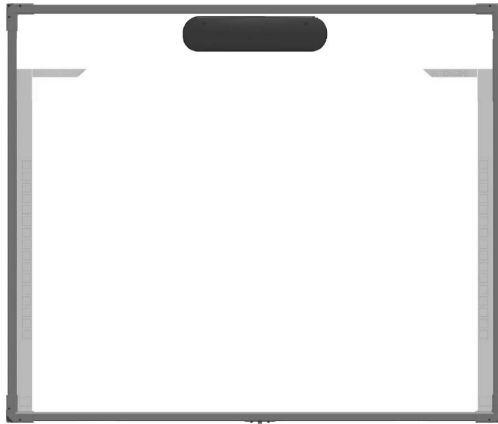

(2)

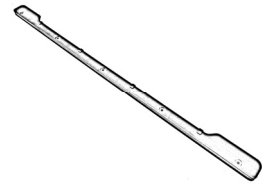

(3)



(4)



(5)

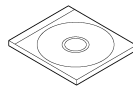

(6)



(7)



(8)

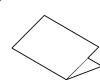

## 1.2.2 Electronic Pen (option)

[1] Parts

No.	Name	Qty
(1)	Electronic pen	1
(2)	AAA alkaline battery	1
(3)	Spare pen tip	2

(1)

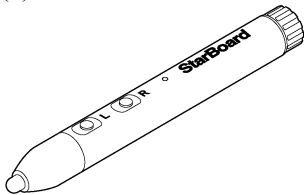

(2)

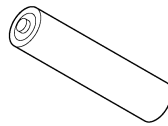

(3)

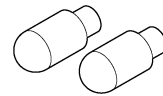



1.3 Role of Each Part



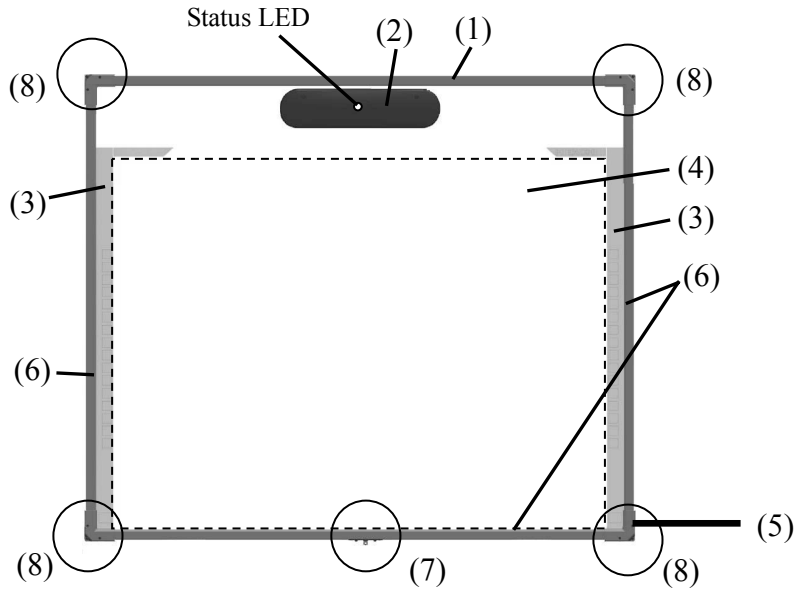













1.3.1 StarBoard

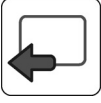

- |  |   |
|--|---|
| <p>(1) Board<br/>Frame and board part of the StarBoard.</p> <p>(2) Digitiser Storage Area<br/>Receives information regarding characters or images drawn with the pen or the user's finger, and transmits this data to the PC.</p> <p>(3) Function Area (Left and Right)<br/>Shortcut buttons for functions that are frequently used in applications are located here. (Refer to the next page for details.)</p> <p>(4) Input Area<br/>Characters or images drawn in this area are imported into the PC. When using the StarBoard in Projection Mode, make sure that the image projected from the projector is kept within this area.</p> | <p>(5) USB Cable<br/>Used to connect the StarBoard with the PC.</p> <p>(6) Reflective Frame<br/>Reflects light. Used to capture pen or finger operations.</p> <p>(7) Wall Fitting Attachment<br/>Used to fix the lower board on the wall.<br/>Use 4-6mm diameter screws.</p> <p>(8) Wall Fixing Hole<br/>Board has four holes to fix the four corners on the wall.<br/>Use 3mm diameter screws.</p> |
|--|---|

1.3.2 Function Area

The function area is provided with shortcut keys for the functions that are frequently used in the StarBoard Software. Use by clicking the middle of the symbol with your pen or finger. With the exception of touch mode/pen mode selection and one-time right click, you can customize the shortcuts with the software for Windows. You cannot customize the shortcuts with the software for Mac. Refer to the online help for details. The default settings are as follows.

Symbol	Description	Symbol	Description
	Select touch mode or pen mode.(*1)		Select Solid Pen (black).
	Select one-time right click. (*1) (*2)		Select Solid Pen (red).
	Hides/displays the StarBoard Software Toolbar.		Select Solid Pen (blue).
	Adds a new blank page.		Select Solid Pen (green).
	Show previous page.		Select Fluorescent Marker Pen.
	Show next page.		Select Eraser.
	Hides/displays the Topic List.		Customisable button 1 (Calibration is set as the default)
	Switch to PC Operation.		Customisable button 2 (Unassigned)

(\*1) These buttons cannot be customised.

(\*2) About one-time right click:

- When the one-time right click function button is pressed, the next finger or electronic pen input becomes right-click operational one time only.
- After the function button is pressed, the one-time right click operation is not canceled until a finger or electronic pen input is made.

### 1.3.3 Electronic Pen (option)

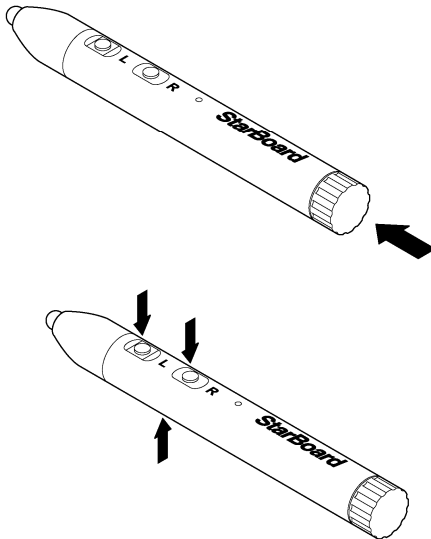

(1) Battery cover

Open the cover when inserting or replacing the battery. Refer to page 2-4 in this User's Guide for details.

(2) Side buttons

Mouse Operations assigned to these buttons. Refer to page 2-6 in this User's Guide for details.

### 1.4 Assembly and Setup

When setting up the board, keep the following in mind.

#### **WARNINGS**

**Install this product on a vertical and flat surface.**

Do not install this product on a slanting surface, ceiling or uneven wall. Otherwise, the equipment might fall, possibly resulting in injury, or the impact might cause product failure.

#### **NOTICE**

- Do not set it up near equipment that might generate electromagnetic waves or radio frequencies, such as radio transmitters, televisions, copying machines or air conditioners.
- Avoid locations that are dusty, that are subject to extremely high or low temperatures or humidity, or that are exposed to direct sunlight.

1.4.1 Setup Method

**⚠ WARNINGS**

**Keep the wall material in mind when installing.**

Installing the board on to the wall in a way that does not suite the wall material, may result in the board falling off the wall causing injuries or damage to the board. Furthermore, wall installation may not be possible depending on the wall. For details, consult with your dealer.

**Keep the wall strength in mind when installing.**

Only use this product after confirming that it is securely attached and will not fall. Furthermore, be sure to install using a wall-mounting bracket capable of supporting a weight of at least 30 kg.

[1] Install of Wall-mounting bracket

Find the height of board installation, and install the Wall-mounting bracket on a wall.

Wall-mounting bracket included in StarBoard ((2) of page1-2)

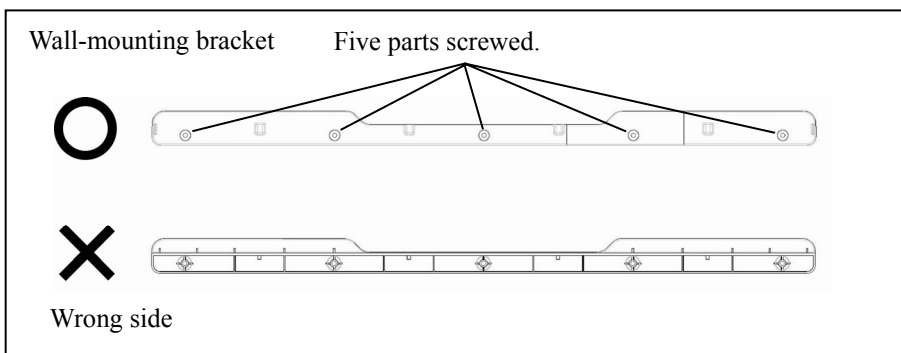
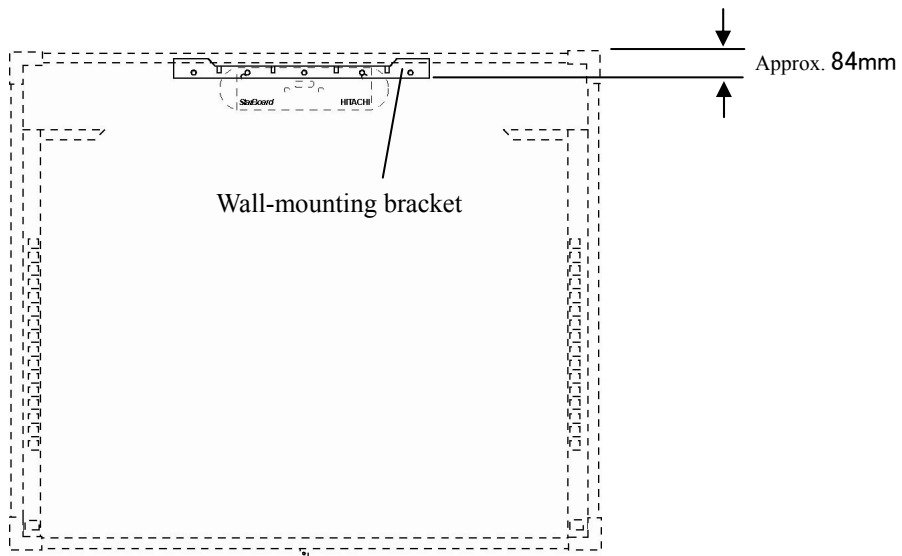

[2] Install the board

**⚠ CAUTION**

**Be sure to use two or more people for this work.**

Failure to comply may cause the board to fall, resulting in personal injury, or may cause damage to this product due to shock of impact.

Hook the hooking part of the stay back of board on the Wall-mounting bracket.  
At this time, USB cable from back of board top should be located the center of Wall-mounting bracket.

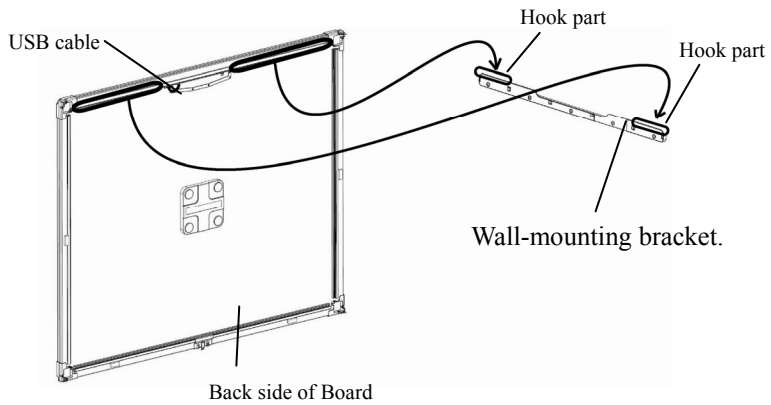

To avoid USB cable located on hook part, do not touch the USB cable with Wall-mounting bracket.

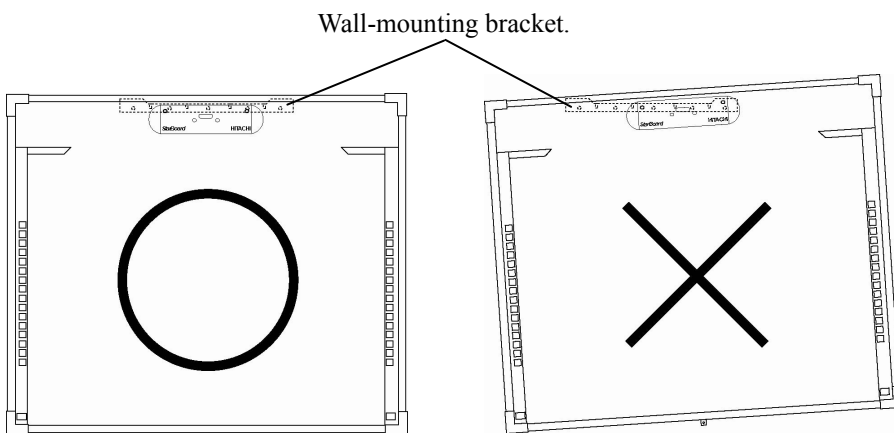

[3] Settle the board

Fix the four corners of board and fitting metal of center of lower board on a wall with screws.

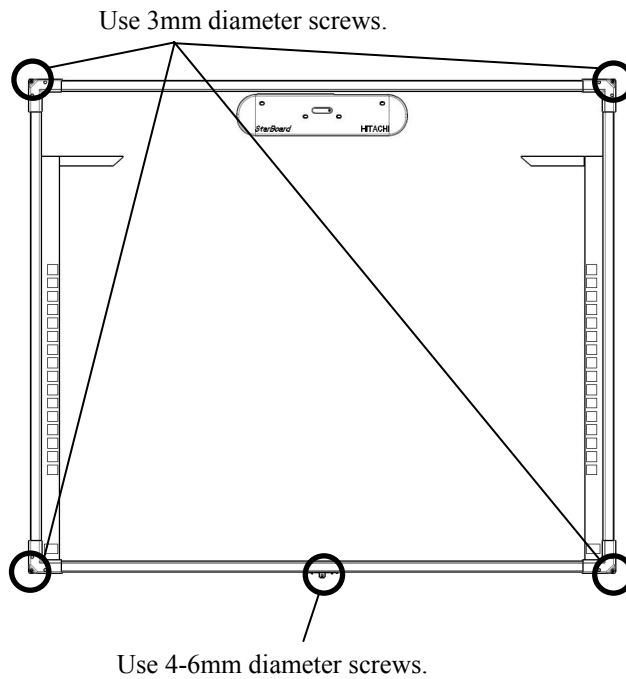

## 1.4.2 Equipment Connection Method

**Before Starting to Connect Equipment**

Install the StarBoard Software on your PC before starting to connect equipment. The equipment might not operate correctly if it is connected without the software being installed.

Connect the PC, projector and StarBoard according to the following procedure.

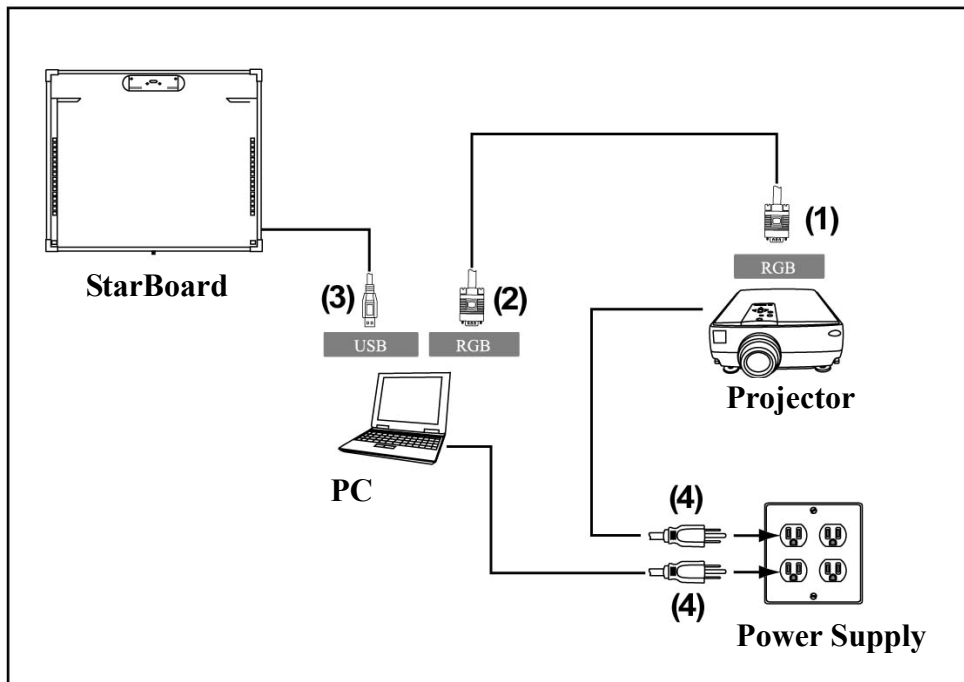

- (1) Connect the RGB cable to the projector's RGB connector, and fasten with screws.
- (2) Connect the opposite side of the RGB cable to the PC's RGB connector, and fasten with screws.
- (3) Connect the USB cable from the lower right of the StarBoard to a USB port on the PC.
- (4) Connect the power supply cables of the PC and projector to the power supply.

**About PC Earth**

Depending on your PC, an incorrect operation might be caused by PC noise via the USB cable. If this happens, verify that the earth of your PC's power supply cable is connected.

If the earth is not connected, it might cause an incorrect operation.

## 2. How to Use

### 2.1 How to Use Touch Mode

This section gives a basic description of how to use the board in touch mode.

#### 2.1.1 Character Input

To input characters, use your finger or the stylus that was provided with the product.

### **NOTICE**

#### **Do not scrape or strike the board surface by stylus pen.**

Failure to comply may result in damage on the board surface.

#### **Use an input tool with a thickness of least 7 mm.**

When inputting to this product, use a tool that is at least 7 mm. If a pen or similar tool with a thickness of less than 7 mm is used, the input will be unstable.

Also, do not use tools with a sharp tip, such as a ballpoint pen. If such a tool is used incorrectly, it could damage the surface of the board.

- Using the stylus pen and Electronic pen

Use the pen on the board with your body kept sufficiently away, so that your palm and elbow do not touch the board. If your hand or elbow touches the board, or you are within 1 cm of the board, it might cause an incorrect operation.

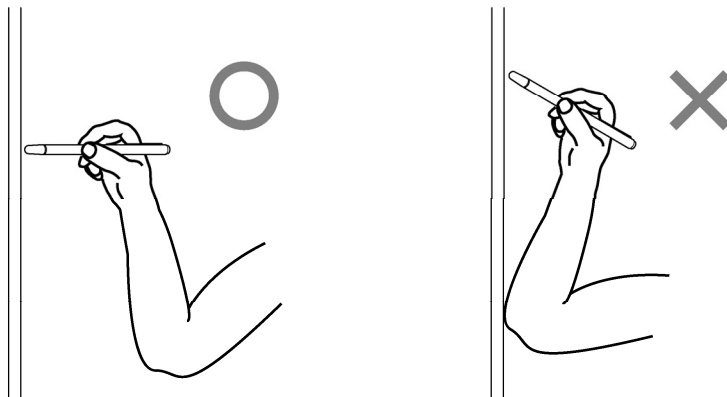



- Using your finger

Extend your finger and touch the board. In the same way as the stylus pen, if you touch the board with anything other than your finger or you are too close to the board, it might cause an incorrect operation.

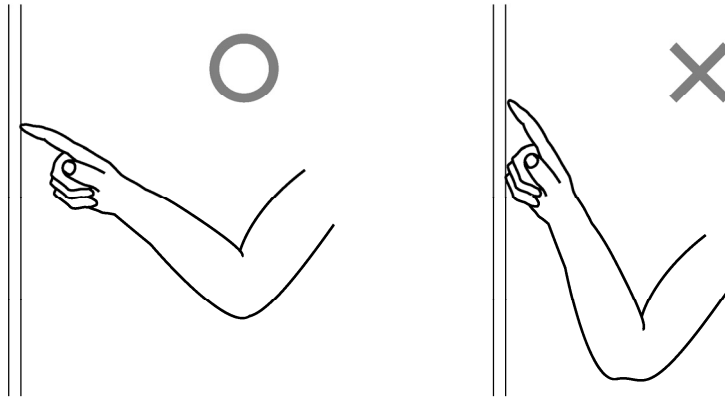

### 2.1.2 PC Operations

When performing PC operations by pointing or giving presentations without inputting characters, it is convenient to extend the stylus pen and use it as a pointer.

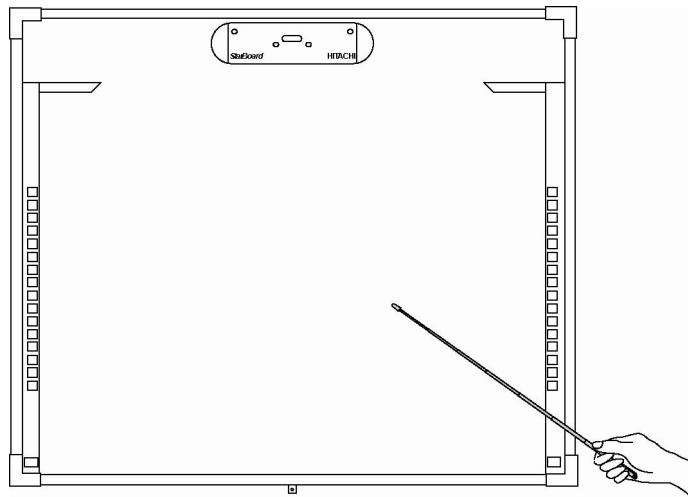

**⚠ CAUTION**

**Do not strike the board forcefully with the stylus pen, bend it, or apply an excessive load to it.**

Failure to comply may result in damage to the stylus pen or personal injury.

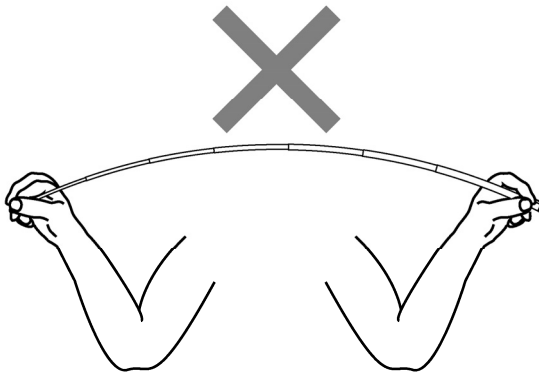

**Important**

**Do not place the stylus pen onto the reflective bar.**

Doing so may cause a sensor error or mistaken detection to occur.



## 2.2 How to User the Electronic Pen

This section gives a basic description of how to use the electronic pen (option).

### 2.2.1 Inserting the Battery

Perform the preparations for using the electronic pen.

#### CAUTION

##### **Be sure to install batteries correctly.**

Do not install batteries with positive and negative terminals reversed, or use batteries other than the type specified. It will cause pen malfunctions and excess heat, or burns to the hand.

##### **Be sure to provide insulation during disposal.**

Be sure to insulate the positive and negative terminals of the battery using cellophane tape, or similar material when disposing of batteries. Disposing of batteries without insulating them may lead to overheating, bursting, or ignition due to shorting, resulting in personal injury or fire. Furthermore, be sure to follow all local rules and regulations regarding proper battery disposal. If within the EU, be sure to follow Batteries Directive. [Batteries directive (2006/66/EC)]

[1] Insert the battery into the electronic pen.

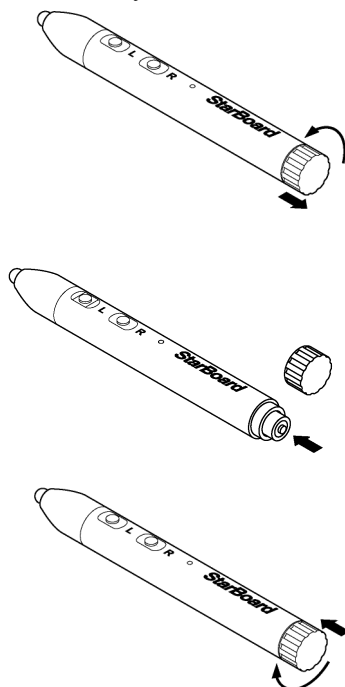

(1) Rotate the battery cover  $\frac{1}{4}$  counter-clockwise, and pull it to remove it.

(2) As shown in the figure, insert the AAA alkaline battery so that the + side faces the outside.

(3) Press the battery cover on, and rotate it clockwise  $\frac{1}{4}$  turn to fix it in place. (Be careful not to over tighten the cover, as doing so may damage it.)

### 2.2.2 Using the Electronic Pen

To use the electronic pen to draw characters or images, place the tip of the electronic pen on the board and then move the pen. When you release the tip of the electronic pen from the board, the writing is complete. Be careful of the following two points when using the electronic pen.

- (1) When drawing with the electronic pen, keep the pen as perpendicular as possible to the board and apply force sufficient enough to cause the pen tip to retract into the electronic pen.
- (2) A miniature transmitter is embedded in the tip of the electronic pen. If you hold the transmitter area of the electronic pen while drawing characters or images, the drawing data from the electronic pen might not be transmitted correctly. If the characters or images drawn on the whiteboard are not imported correctly into the PC, change your grip on the electronic pen and then verify that they are displayed correctly.

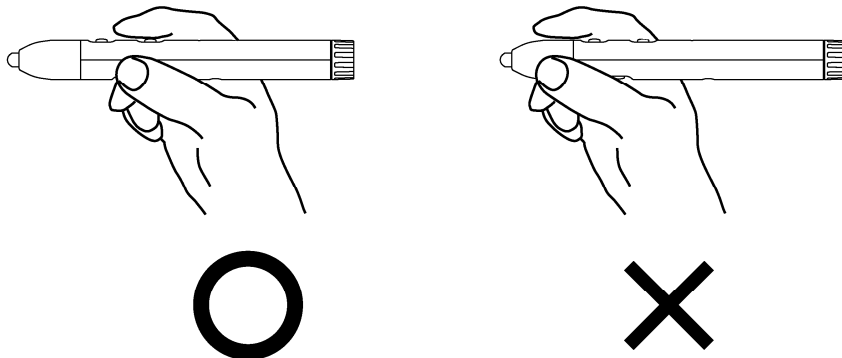

#### **Blocking of the Infrared Beam**

Electronic pen operations are detected when the digitiser reads the infrared beams that are generated by the pen. If the beam between the electronic pen and the digitiser is blocked, normal input becomes impossible. Avoid blocking them during use.

**2.2.3 Basic Operations of the Electronic Pen**

In the default settings of the electronic pen, the pen tip button is set to the left button of the mouse in Windows and the main button click in Mac. You can use the pen tip button to perform the following mouse operations while Windows or Mac is running.

The following xxxx/xxxx description is for functions and operations in a Windows environment or Mac environment.

- Left click / Primary mouse button click

Push the pen tip onto the board with sufficient force and then quickly move the pen away from the board.

- Double click / Primary mouse button Double click

Push the pen tip onto the board with sufficient force, and quickly move the pen away from the board two times in the same spot.

- Drag / Drag

Push the pen tip onto the board with sufficient force, and without releasing it away from the board, move it from one point to another.

**2.2.4 Customizing the Electronic Pen**

The electronic pen has one pen tip button and three side buttons. Mouse actions can be assigned to these four buttons.

The default button settings are shown in the following table.

Button Name	Function	
	Windows *	Mac
Pen tip	Left click	Primary mouse button click
L (Side button No. 0)	Left double click	Primary mouse button Double click
R (Side button No. 1)	Right click	Secondary Button click
C (Side button No. 2)	Hides/displays the StarBoard Software Toolbar	Hides/displays the StarBoard Software Toolbar

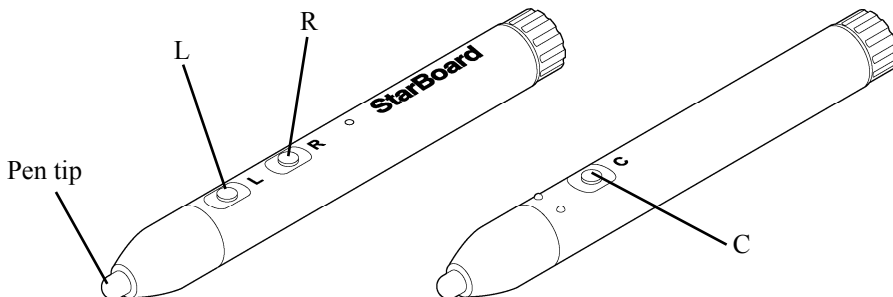

\* The assignment of the side button can be changed by selecting "MENU" on the StarBoard Software toolbar → "Settings" → "StarBoard" → "StarBoard Settings" → "Configure pen buttons" (This function can only be changed in Windows.)

## 2.3 Start Method

### 2.3.1 Start Method (Windows version)

- (1) Connect the devices with reference to the connection method on page 1-10.
- (2) Turn on the power switch of the projector.
- (3) Turn on the power switch of the PC to start Windows.
- (4) Adjust the position of the projector so that the Windows screen projected by the projector is within the input area (refer to page 1-4 of this User's Guide).
- (5) Select "Start" → "All Programs" → "StarBoard Software," or double-click the StarBoard icon on the desktop.

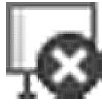

If the "No connection" icon in below appears on the Tasktray, it means that the StarBoard is not connected. Make sure that the StarBoard and the PC are properly connected.

Connected	No Connection
	

If the StarBoard is properly connected, the icon changes to "Connected" as above. If the icon does not change despite correcting the connection, there may be some other problem. For details, refer to "3. Appendix 3.1 Troubleshooting" on page 3-1 of this User's Guide.

- (6) Run "LsCamWiz.exe" located under "My Computer" → "C Drive" (\*) → "Program Files" → "Hitachi Software Engineering" → "FX-DUODriver", and adjust the sensor according to the instructions on page 3-5.

(\*)This folder path may be changed since it depends on your Windows installation.

If the positions of the pen tip and cursor are out of alignment, select "MENU" on the StarBoard Software toolbar → "Settings" → "StarBoard" → "Calibrate," and then perform position alignment.

### **Important**

**Conduct sensor adjustments upon first-time operations and whenever the board has been moved.**

Not doing so may cause operation errors.

#### 2.3.2 Start Method (Mac version)

- (1) Connect the devices with reference to the connection method on page 1-10.
- (2) Turn on the power switch of the projector.
- (3) Turn on the power switch of the PC to start Mac
- (4) Adjust the position of the projector so that the Mac screen projected by the projector is within the input area (refer to page 1-4 of this User's Guide).
- (5) Select "Go" → "Applications" → "StarBoard Software" to start StarBoard Software.
- (6) Select "MENU" on the StarBoard Software toolbar → "Settings" → "StarBoard" → "Check Connection," and then check the connection.

If the "StarBoard is not connected" message appears, StarBoard Software has not detected the StarBoard. Check whether the StarBoard and PC are connected properly.

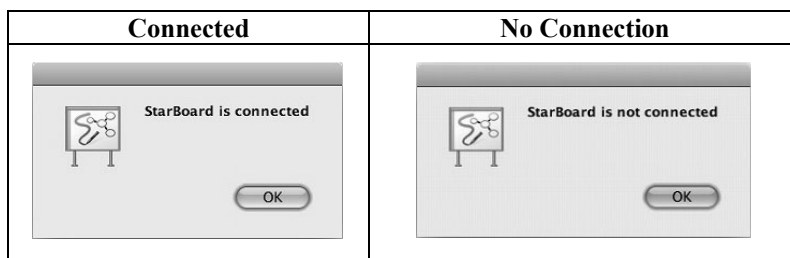

If they are connected properly, the "StarBoard is connected" message appears. If the indication does not change even though you have checked the connection, there is likely to be some problem. For details, see "3. Appendix Troubleshooting" on page 3-1 in this user's guide.

- (7) Start "Go" → "Applications" → "Lsdrv" → "LsCamWiz," and then adjust the sensor in accordance with the procedure on page 3-7

If the positions of the pen tip and cursor are out of alignment, select "MENU" on the StarBoard Software toolbar → "Settings" → "StarBoard" → "Calibrate," and then perform position alignment.

**Important**

**Conduct sensor adjustments upon first-time operations and whenever the board has been moved.**

Not doing so may cause operation errors.



### 3. Appendix

#### 3.1 Troubleshooting

Before assuming the product is broken, be sure to check adjustments, proper handling procedures, the possibility of faulty cable connections, etc.

#### Recognition-Related Problems

Problem	What to check	What to do
The StarBoard does not recognise input.	Is the USB cable connected to the PC?	Connect the USB cable to the PC.
	Is the status LED (page 1-4) lit green?	Check the USB cable connection.
	Did you start the system in the correct sequence?	Start the system in the correct sequence. (For details on starting the system, see page 2-7 of this User's Guide.)
	In case that USB cable extended as bellow, it may result in unstable of product working. • USB extension cable • Bus-powered USB hub • USB extender	Quit the USB cable extend, plug USB cable to PC directly. If you need to extend USB cable, use self-powered USB hub.
	StarBoard Software files may be broken or installation may not be complete correctly.	Uninstall the StarBoard Software and then re-install it. (For details on installing StarBoard Software, see the StarBoard Software Installation Guide.)
	Other than the above	Contact a support center.
The StarBoard does not recognise input. (In case the driver could not be found.)	“Optical Touch Sensor” exists on USB controller of the Device Manager.	Update the driver software.
Touch Sensor Error (Something is blocking light from reaching the board surface or reflective tape. Or sensor adjustment is not properly. StarBoard can not detect the input.)	Is something blocking light from reaching the board surface or reflective tape?	Remove the blockage.
	Are the silver surfaces of the reflective bars dirty?	Use a soft brush to clean the silver surfaces of the reflective bars.
	Other than the above	Adjust the sensor. (See page 3-5 of this User's Guide.)
Touch Sensor Error (USB error)	The controller must be reset and the system restarted.	Disconnect the USB cable and reconnect it. If this does not solve the problem, restart the PC.

Problem	What to check	What to do
	In case that USB cable extended as bellow, it may result in unstable of product working. <ul style="list-style-type: none"><li>•USB extension cable</li><li>•Bus-powered USB hub</li><li>•USB extender</li></ul>	Quit the USB cable extend, plug USB cable to PC directly. If you need to extend USB cable, use self-powered USB hub.
Touch Sensor Error (Insufficient USB bandwidth)	Is a high-speed USB device connected to the USB host controller used to connect the StarBoard?	Be sure to connect the StarBoard and any high-speed USB devices to separate USB host controllers. Be sure to use a USB hub in the case of PCs with only one USB host controller.

**Input-Related Problems**

<b>Problem</b>	<b>What to check</b>	<b>What to do</b>
The input position does not match.	Has position alignment been performed properly?	Perform proper position alignment.
	Other than the above	Contact a support center.
The position cannot be aligned properly.	Have the StarBoard and projector been placed in the proper orientation?	Adjust the position of the StarBoard and the projector. If undue correction is performed, it may not be possible to align the position properly.
	Is the PC screen being projected inside the StarBoard's input area?	Make sure the PC screen projection is contained within the StarBoard's input area. (For details on the input area, see page 1-4 of this User's Guide.)
	StarBoard Software files may be broken or installation may not be complete correctly.	Uninstall the StarBoard Software and then re-install it. (For details on installing StarBoard Software, see the StarBoard Software Installation Guide.)
	Other than the above	Contact a support center.
The electronic pen does not work.	This may be due to faulty contact of electronic pen batteries.	Remove the batteries from the electronic pen and re-install them.
	Are batteries used up?	Replace the batteries. (For details on battery replacement, see page 2-4 of this User's Guide.)
	StarBoard Software files may be broken or installation may not be complete correctly.	Uninstall the StarBoard Software and then re-install it. (For details on installing StarBoard Software, see the StarBoard Software Installation Guide.)
	Is there a nearby light source with a wavelength close to that of the electronic pen? (Illumination from fluorescent lighting or similar source)	Check by turning off the lights in the room. If the StarBoard operates normally, change the location in which it is installed or change the lighting fixtures.
	Other than the above	Restart Windows/Mac OS or StarBoard Software.  Check if the same problem arises when using another electronic pen. If operations are normal when using another electronic pen, the original pen is the problem.  Contact a support center.

Problem	What to check	What to do
Electronic pen operation is unstable or stops.	Is a remote controller for AV equipment being operated while using the pen?	Stop operating the remote controller.
	The battery charge of the electronic pen may be low.	Replace the batteries. (For details on battery replacement, see page 2-4 of this User's Guide.)
	StarBoard Software files may be broken or installation may not be complete correctly.	Uninstall the StarBoard Software and then re-install it. (For details on installing StarBoard Software, see the StarBoard Software Installation Guide.)
	Other than the above	Restart Windows/Mac OS or StarBoard Software.  Check if the same problem arises when using another electronic pen. If operations are normal when using another electronic pen, the original pen is the problem.

## 3.2 Adjusting the Sensor

### NOTICE

Using infrared and compact cameras, this product captures the image (shadow) of a pen or finger and detects the corresponding coordinate position. Do not operate near lighting that will obstruct the capture of the image.

- Locations where the surface or side of the projection area are exposed to direct sunlight.
- Locations in which there are light fittings with many light bulbs or infrared rays directly above the projection area.

### 3.2.1 Items to Check Before Making Sensor Adjustments

The following error may appear while using this product.



(Windows)



(Mac)

The window may be displayed hidden behind another window.

Check the following items if this error appears.

- Check that light is not blocked from reaching the board surface or reflective tape.
- Check that the reflective tape is not dirty.

If the problem is not corrected despite making the above checks, In the operating system you are using, perform adjustment in accordance with " Sensor Adjustment Procedure " shown in Section 3.2.2 in the case of Windows and 3.2.3 in the case of Mac OS.

### 3.2.2 Sensor Adjustment Procedure (Windows version)

- [1] Press the "Adjust Camera" button on the "LSaDrv Touch Sensor Error" dialog box displayed on the PC screen.

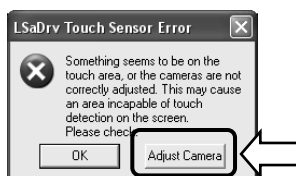

#### Manual Startup

In order to manually run the sensor adjustment wizard, open "My Computer" and execute "LsCamWiz.exe" located under "C Drive" (\*) → "Program Files" → "Hitachi Software Engineering" → "FX-DUODriver".

(\*)This folder path may be changed since it depends on your Windows installation.

[2] "Camera Adjustment Wizard Start" window appears. Press "All Adjust."

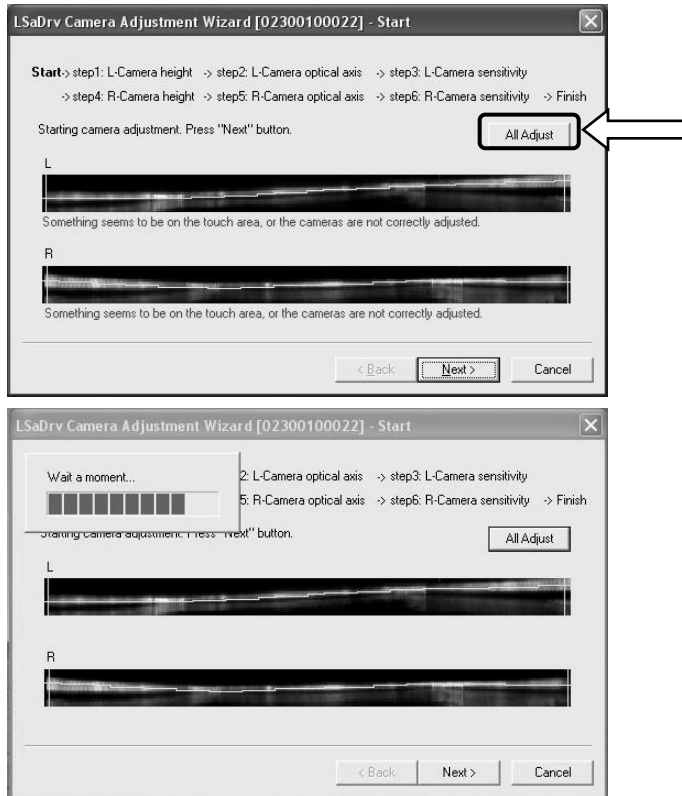

[3] Press "Finish"

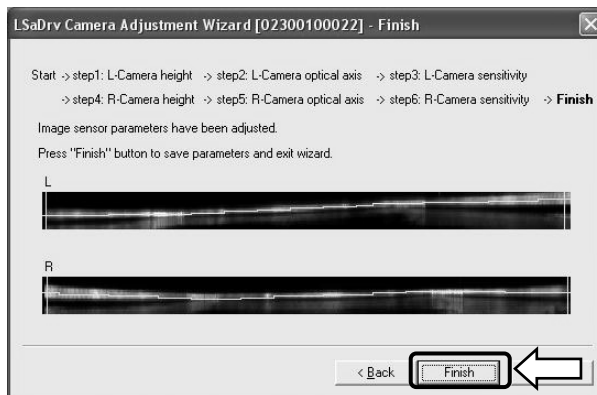

This completes sensor adjustment.

After making adjustments, check that input can be performed normally.

3.2.3 Sensor Adjustment Procedure (Mac version)

[1] Press the "OK" button on the "LSaDrv Touch Sensor Error" dialog box displayed on the Mac screen.



[2] Start the sensor adjustment wizard.

Start "Go" → "Applications" → "StarBoard" → "Lsdrv" folder → "LsCamWiz."

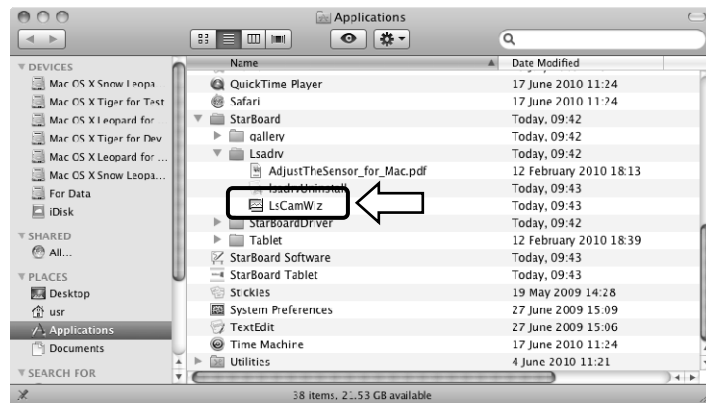

[3] The sensor adjustment wizard starts. Click the "All adjust" button.

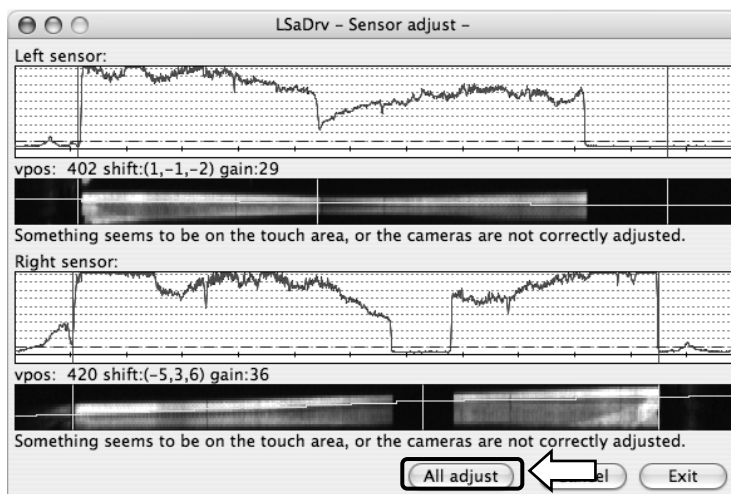

[4] Wait a while. If the "LsCamWiz ERROR" message does not appear, sensor adjustment was successful. If an error such as the following appears, click the "OK" button and then perform adjustment again while referring to Section 3.2.1. If adjustment is still not successful, the StarBoard unit may be defective.



[5] If adjustment was successful, click the "Exit" button.  
\* Note that just clicking the button does not complete the adjustment process.

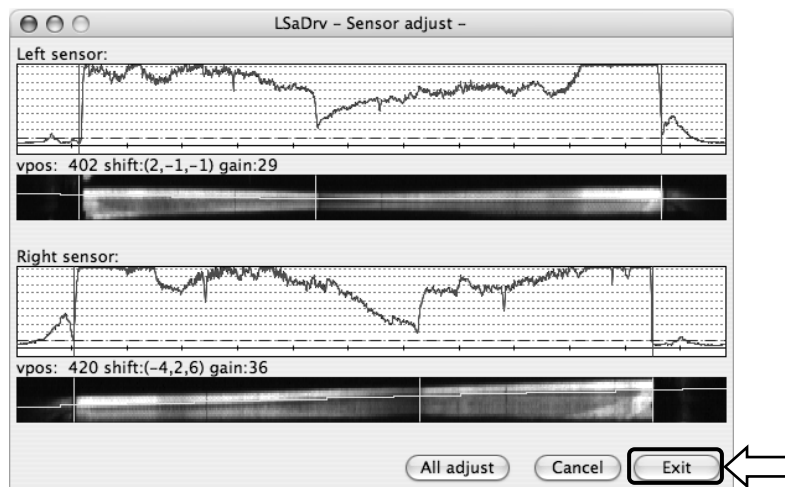

[6] To save the adjustment result, click the "Yes" button.

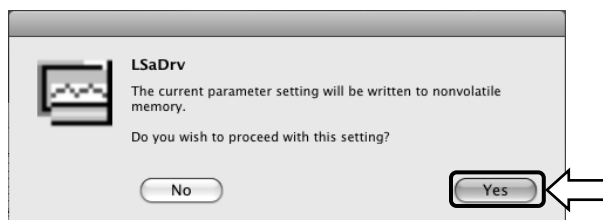

This completes sensor adjustment.

After making adjustments, check that input can be performed normally.



### 3.3 Regularly Auto Sensor Adjustment (For Windows)

While using StarBoard, auto sensor adjustment will execute regularly. To use StarBoard comfortably this function is recommended to use. You cannot use this Adjustment for Mac.

#### NOTICE

Using infrared and compact cameras, this product captures the image (shadow) of a pen or finger and detects the corresponding coordinate position. Do not operate near lighting that will obstruct the capture of the image.

- Locations where the surface or side of the projection area are exposed to direct sunlight.
- Locations in which there are light fittings with many light bulbs or infrared rays directly above the projection area.

#### 3.3.1 Sensor Auto Adjustment Procedure

[1] Confirmation message of auto sensor adjustment will be displayed after 7days as default passed from first connect of StarBoard to PC. If you press “Yes”, auto sensor adjustment program will execute. If you press “No”, this will not execute.

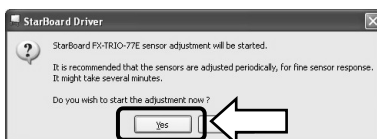

#### Manual execute /

#### Change of auto execute interval of the sensor adjustment

#### Manual execute

For the manual execute, select “MENU” – “Settings” – “StarBoard” – “StarBoard Settings” and press [1]“Sensor adjustment” in the StarBoard toolbar.

#### Change of auto execute interval of the sensor adjustment

For the auto execute interval of the sensor adjustment select from 0 to 30 by [2] button. If you select “0”, auto execute is disable.

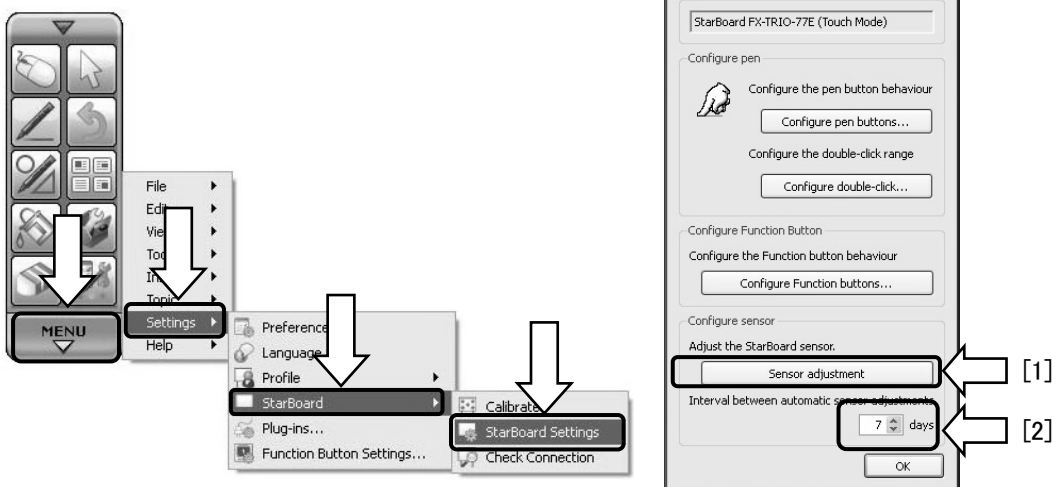

- [2] Sensor adjusting screen will be displayed during auto adjustment. Do not touch the board surface until auto adjustment completed.

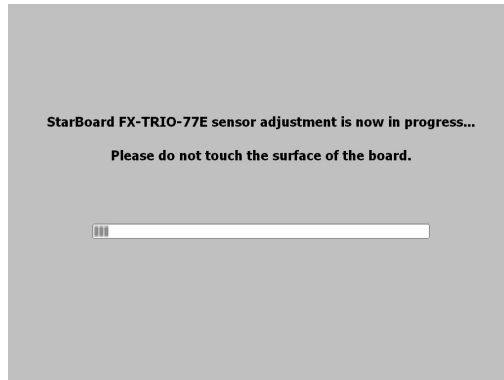

- [3] Following window will be displayed when sensor auto adjustment finished. Press "OK".

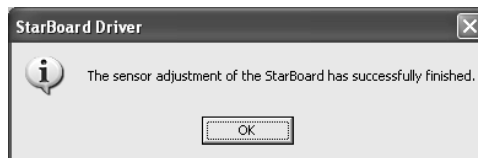

This is all of auto sensor adjustment.  
Confirm the normal input after adjustment

- \* In case of adjustment error, following window will be displayed. Press "Retry" to auto sensor adjustment program execute again.

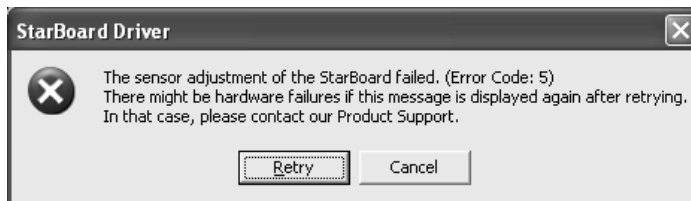

If this message displayed again, StarBoard may have some problem. Please Contact our support.

3.4 System Specifications

Item	Specification	
Model name	StarBoard FX-TRIO-63E	StarBoard FX-TRIO-77E
Detection method	Infrared image sensor system* <sup>1</sup>	
Digitiser resolution	0.05mm	
Sampling rate	Approx. 100 points/second when using (USB1.1 Full Speed)	
Interface	USB 1.1 (cable length: 5.1 m)	USB 1.1 (cable length: 4.7m)
Effective screen size (mm)	Approx. 63inches 1,285(W)×961(H)	Approx. 77inches 1,573(W)×1,180(H)
Board dimensions (mm)	1511(W)×1,260(H)×65 (D) (not including fitting metal of lower board on a wall)	1,756(W)×1,481(H)×65 (D) (not including fitting metal of lower board on a wall)
Power consumption	5V 500mA	
Weight of main unit	Approx. 11kg	Approx. 14 kg
Operating requirements	+5°C – 35°C (Humidity: 20 – 80% RH, without condensation)	
Storage requirements	-10°C – +45°C (Humidity: 20 – 80% RH, without condensation)	
Electronic pen (option)	Communication system: Infrared (Carrier wavelength: 56 kHz, IR wavelength: 940 nm)* <sup>2</sup> Side switches: 3 Power supply: AAA Expected battery life: Approx. 80 hours of continuous use* <sup>3</sup> (alkaline battery ) Size: 149 mm × φ 17 mm Weight: Approx. 20 g (not including batteries)	
Standards, etc.	VCCI Class A FCC Class B, CE	

\*1 Using infrared and compact cameras, this product captures the image (shadow) of a pen or finger and detects the corresponding coordinate position. Do not operate near lighting that will obstruct the capture of the image. This includes:

- Locations where direct sunlight strikes the board surface or comes from the side.
- Locations with white incandescent lighting or strong infrared source directly overhead.

Depending on installation conditions or sensor property, position detection may be off by about 9 mm.

\*2 The electronic pen uses infrared light having the same frequency (approx. 940 nm).

Do not operate this product in a location where other equipment (fluorescent lighting, plasma displays, passive sensors, etc.) may emit a similar frequency.

\*3 The expected battery lifetime may vary depending on initial battery conditions, humidity, and the operating environment.

### 3.5 Proper Care and Cleaning

Clean the StarBoard periodically so that you may use it for a long time to come.

(1) Cleaning the StarBoard

- To clean the StarBoard, use a soft cloth dampened with whiteboard cleaner or a diluted neutral cleansing agent that does not contain a polishing compound.
- Never use a solvent such as thinner.
- Note that rubbing or striking the StarBoard surface with a finger nail or other hard object may result in scratching.

(2) Cleaning the silver surfaces of the reflective bars

- Use attached brush to clean the silver surfaces of the reflective bars.
- Do not use water or liquids.
- Note that rubbing or striking the silver surfaces of the reflective bars with nails or hard objects may result in scratching. The product may not work correctly if scratched.

(3) Cleaning the electronic pen

- To clean the electronic pen, use a diluted neutral cleansing agent that does not contain a polishing compound. Do not apply the neutral cleansing agent directly, but rather dampen a soft wet cloth with a mixture of water and the cleaner, and wipe. Never use a solvent such as thinner.
- Do not allow the pen tip to get wet.

### 3.6 Replaceable Parts

- (1) Stylus pen
- (2) AAA alkaline battery
- (3) Spare pen tip

For details on obtaining them, contact your dealer or a support center.

### 3.7 Product Warranty Policy

1. During the free warranty service period, if a malfunction occurs during normal use, the malfunction will be corrected without charge, according to the provisions of the warranty. Furthermore, if the customer registration card accompanying the warranty is not returned to our company, the customer information will not be registered; so free repairs might be unavailable. After receiving this product, please immediately fill out and return this customer registration card.

2. The warranty coverage is listed in the following table:

<b>Product Name</b>	<b>Part Name</b>	<b>Warranty Coverage</b>
StarBoard	Digitiser	+
	Stylus Pen	–
	Function Area Sticker	–
	Reflection Tape parts	–
	Wall-mounting bracket	–
Electronic Pen	Electronic Pen	+
	AAA alkaline battery	–
	Spare Pen Tips	–

(Explanatory note): + → Covered by warranty (excluding wear or physical damage)

– → Not covered by warranty

3. Please refer to the warranty sheet for this product's warranty service period.

4. Even during the warranty period, there will be a repair charge in the following cases:

- (1) If the registration card accompanying the warranty is not returned to our company.
- (2) If the warranty is not presented.
- (3) If specified fields on the registration card accompanying the warranty are not completed, or if the wording has been changed without authorisation.
- (4) The warranty applies only to the original purchasers. (It does not apply to a third party to whom the customer resold this product.)
- (5) In the event of a malfunction or damage resulting from the customer's improper handling (e.g., a fall, impact, etc., caused by the customer during transportation or movement).
- (6) In the event of problems resulting from handling contrary to the handling and precautions mentioned in this user's guide.
- (7) In the event of failure or damage resulting from abnormal voltages, pollution or other natural disasters (e.g., fire, earthquake, and lightning).

- (8) In the event of a malfunction in this product caused by the connection to this product of equipment other than the equipment specified by our company.
  - (9) In the event that there is no abnormality in this product, but a defect in a part other than this product was detected or remedied.
  - (10) In the event of ordinary wear and tear, wear, deterioration, etc., of consumables, even during normal use.
5. If this product malfunctions, review the contents of this user's guide. If the problems remain irreparable, contact the dealer. The dealer will determine whether or not the product must be repaired, so please contact them. If the customer sends the product to our company without RMA (Return Merchandise Authorisation) number, it might not be covered by warranty.
  6. As a rule, the customer is responsible for shipping charges required to send all or part of the product for repair, etc. Our company will assume responsibility for the return shipping to the customer.
  7. This warranty does not cover labour fees for repair-associated equipment assembly or disassembly.
  8. Incidental damage caused by the failure of this product (e.g., loss of profit that should have resulted from the use of this product) is outside the scope of this warranty.
  9. The aforementioned provisions define this warranty, and they supersede those of all express or implied warranties that include legal defect liability.
  10. No warranty if customer fixed the product in a method other than our company specified. Our company has no responsibility for compensation of board falling accident.
  11. This warranty is limited to use of this product within the country where the user bought this product.